

BS Flange System

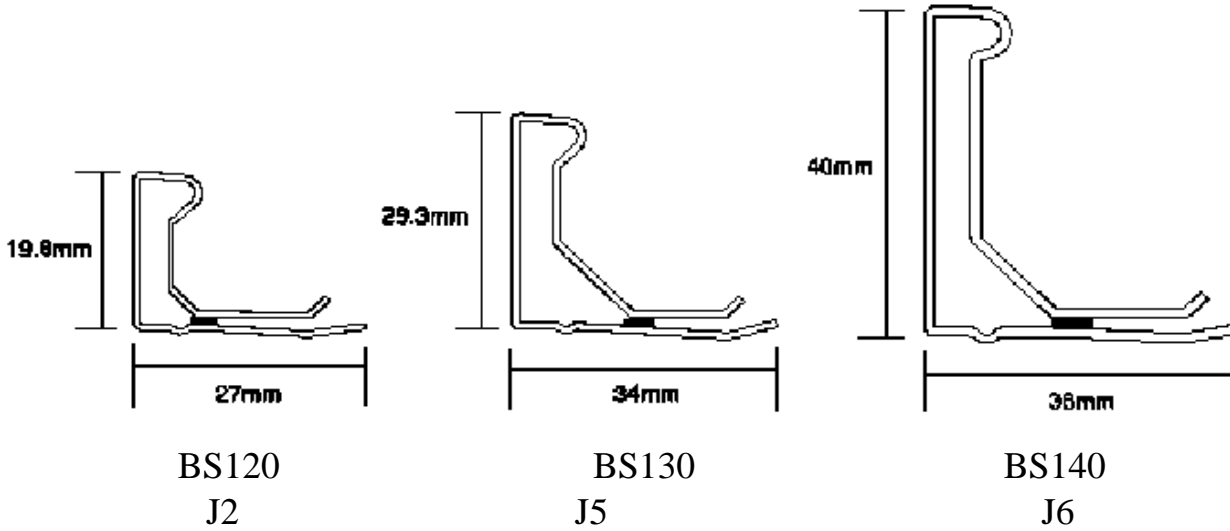

Flange with Mastic

Code	Size	Gauge	Length	Price per Length
BS120	20mm	0.8 mm	5 metre	6.25
BS130	30mm	1.0 mm	5 metre	8.50
BS140	40mm	1.25 mm	5 metre	17.98

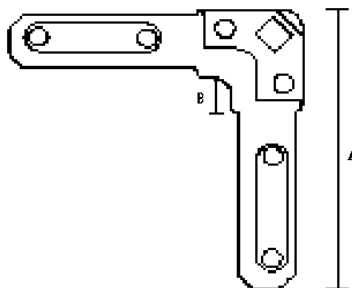

BSS20 for ducts up to 400mm
 BSS20 A=60mm B=15mm
 BS20 A=95mm B=15mm
 BS30 A=105mm B=15mm
 BS40 A=120mm B=15mm

Corner Pieces

Code	Description	No. in Box	Price per Box
BSS20	20mm Short Corners	200	36.00
BS20	20mm Long Corners	200	48.00
BS21	20mm Through Corners	200	56.70
BS30	30mm Corners	100	40.00
BS40	40mm Corners	100	96.06

Fixings

Code	Description	No. in Box	Price per Box
CM	Flange Clamp	100	38.15

Cleats also available

Track and Vane

Code	Description	Price
TVT	Turning Vane Track x 3m	4.16
TV	Turning Vane x 3m	4.40

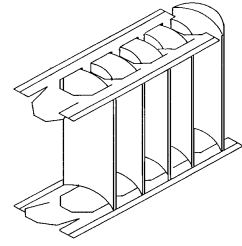

Flexible Duct Connector

Code	Description	Price
JDP25	JDP Duct Connector x 25m	75.25
KEV25	KEV Duct Connector x 25m	47.50

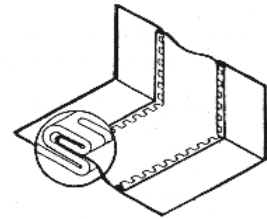

Damper Sets

Code	Description	Price
MINI	Cast Quadrant - up to 250mm Ø	6.08
MINOR	Cast Quadrant - 250mm - 500mm Ø	8.56
MAJOR	Cast Quadrant - 500mm + Ø	11.58
DQ-1	Damper Quadrant for Duct upto 350mm	1.26
DQ-2	Damper Quadrant for Duct upto 500mm	2.21
DQ-3	Damper Quadrant for Duct upto 700mm	2.78

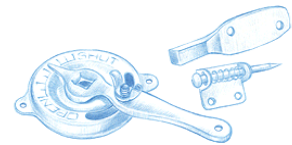
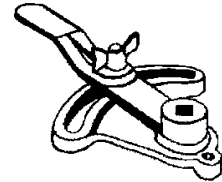

Foam Gasket Tape

Suitable for Flanging Systems

Code	Size	Price
G-15	6mm x 15mm x 15m	1.76
G-20	6mm x 20mm x 15m	2.30
G-25	6mm x 25mm x 15m	2.90

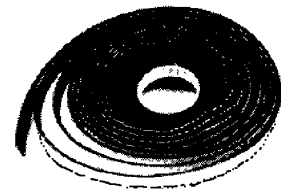

Butyl Rubber Gasket Tape

Code	Description	Price
BT-19	19mm x 3mm x 15m	5.28